

THE BEST SOLUTIONS –
THE RESULT OF A GOOD PARTNERSHIP

AseptraLine® | FiltraLine® | MembraLine®



For us, special solutions are standard!

The right partner for your needs

You need a very special solution for your application? We offer contract manufacturing and cooperate closely with our customers to produce individualized solutions or complete systems of the highest quality in stainless steel.

Our specialists are at your side with advice for each project from the very beginning, ensuring that you get the best support right through until delivery. Decades of experience, state-of-the-art technologies and production methods, an end-to-end production chain, our own design department, and precise quality control procedures guarantee excellent product solutions. That makes us your reliable and competent contract manufacturing partner from the planning stage to the manufacturing of individual components, and even the installation of entire systems.

PROCESS TANKS

PLANT CONSTRUCTION

MEMBRANE HOUSINGS

EXTRUSIONS

**SOMMER &
STRASSBURGER**

CUSTOM MANUFACTURING

FILTER HOUSINGS

HEAT EXCHANGERS

What makes us special

More than 30 years of experience in stainless steel processing and more than 100 employees give you the assurance of working with a competent partner. The uncompromising fulfillment of our customers' quality requirements is the basis of our success.



Perfection in all areas of application

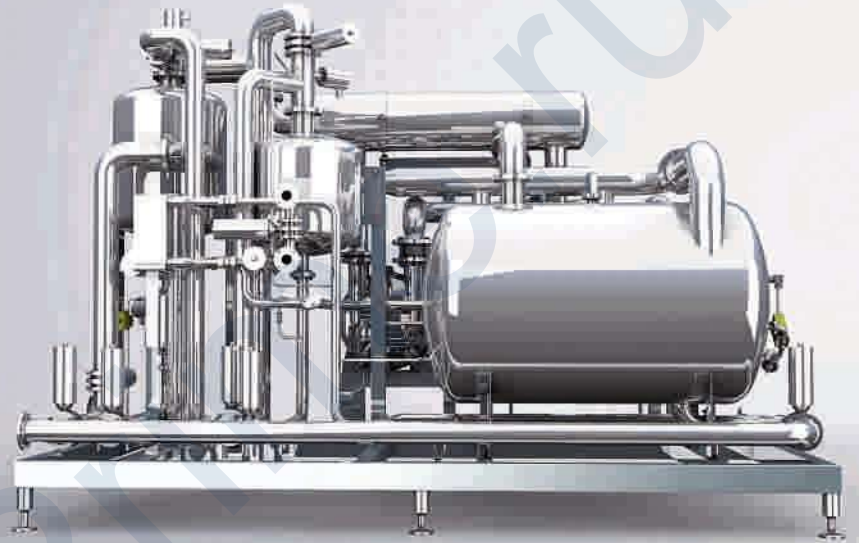

PHARMA- CEUTICALS



FOOD & BEVERAGE



Thanks to our great versatility, we cover a broad range of applications. Depending on the customer's needs and requirements, we work together to develop the desired solution. Our own surface finishing processes, such as immersion pickling, grinding, electropolishing, or glass bead blasting, make us meet even the highest requirements for quality, such as those needed in the pharmaceutical industry.

As a pure stainless steel processor, we offer the optimal prerequisites for demanding tasks. With our team of welders, tank and apparatus builders, and experts in machining processes, all certified by the German Technical Standards Organization (TÜV) and by ASME, we carry out complex projects.

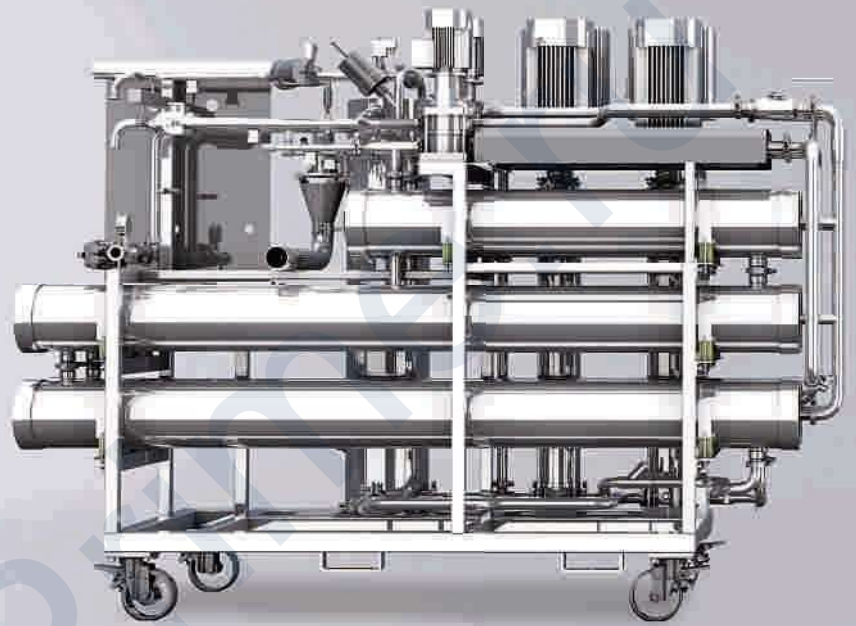

CHEMISTRY



WATER

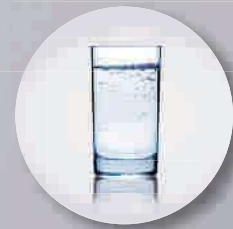

Our lathe shop, milling shop, and tank production unit enable us to deliver flexible, customer-oriented solutions and custom-made products to meet the highest demands of the pharmaceutical and food industries. This can be accomplished due to continuous further development of our human resources and technology.

Tanks and systems that offer process reliability and precision demonstrate our close partnership and collaboration with our customers as well as a high level of confidence in the performance of Sommer & Strassburger.

Plant construction

The great experience of Sommer & Strassburger, as well as their outstanding production depth, ensure precision and quality down to the last detail. Implementation from 3D drawing to complete plant construction.

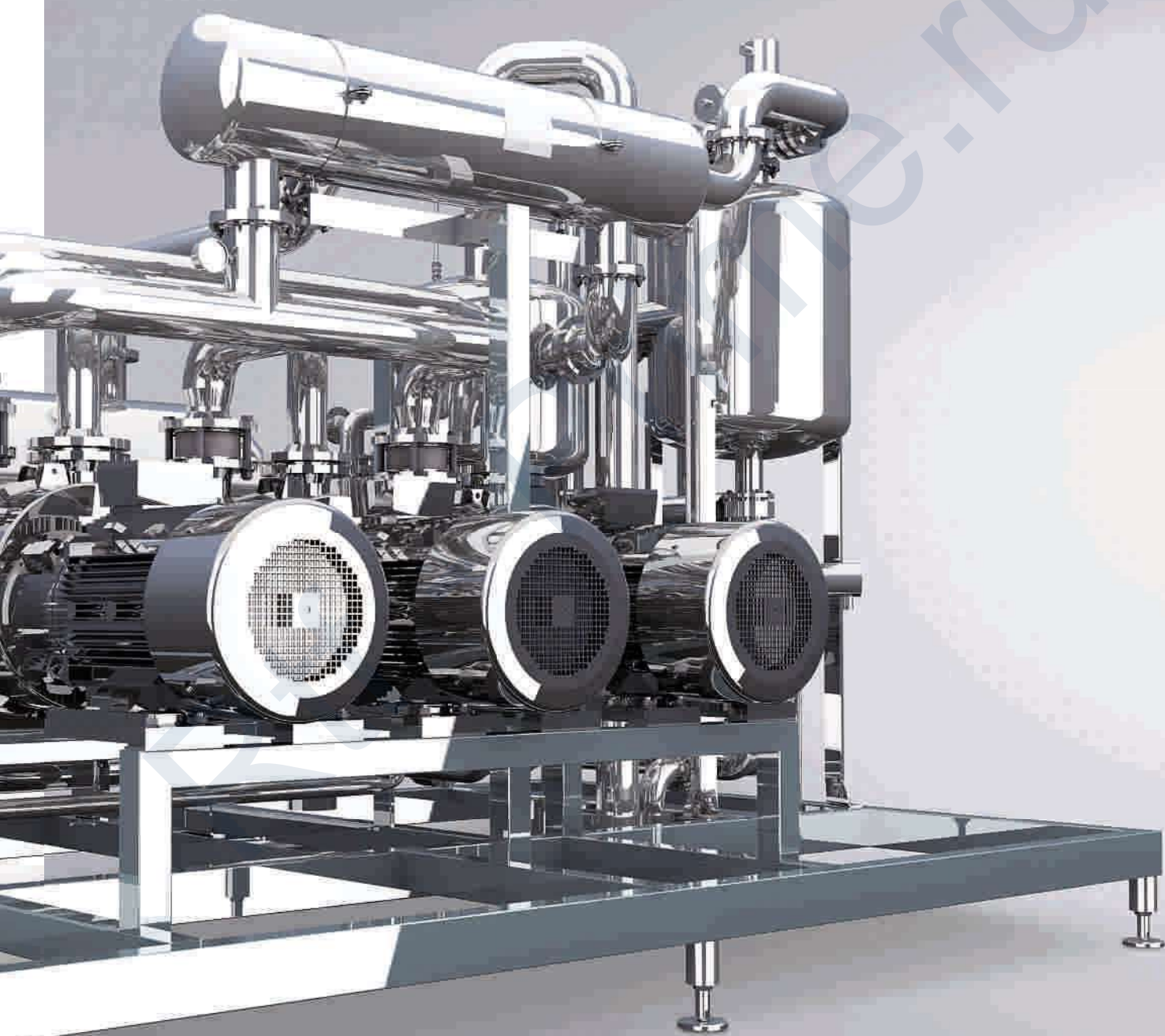

Examples of our plant construction portfolio



Reverse osmosis plant

For water treatment.

Pasteurization plant

Complete solutions from tube in tube to multitube to regenerator.



Pharmaceutical valve block

All welds are orbital-welded.

Production facility specifications:

- › Hall area 1,200 m²
- › Crane height 9.5 m
- › In-house customer FAT

AseptraLine® – process tanks and welded pads

Hygienic solutions are our core business –
as demonstrated by our special product line
AseptraLine® with connections according
to DIN 11864-2.



Hygienic welded pad with
connection according to DIN 11864-2

Flush design for optimal cleaning.

Examples of our process tank production

Process tanks

With heating/cooling and insulating jacket up to \varnothing 2,000 mm.



Agitating tank

You supply the agitator, we manufacture the tank.



Process filter

Based on customer requirements, we make process filters for gaseous, liquids, and hazardous media.



Tank production facility specifications:

- › Tanks up to \varnothing 2,000 mm and wall thickness up to 20 mm
- › Materials: e. g. AISI 316, 316 L, 316 Ti, 304

MembraLine® membrane housings

Sommer & Strassburger is a well known European manufacturer of stainless steel membrane housings for membrane processes. Areas of application include ultra- and nanofiltration or reverse osmosis.

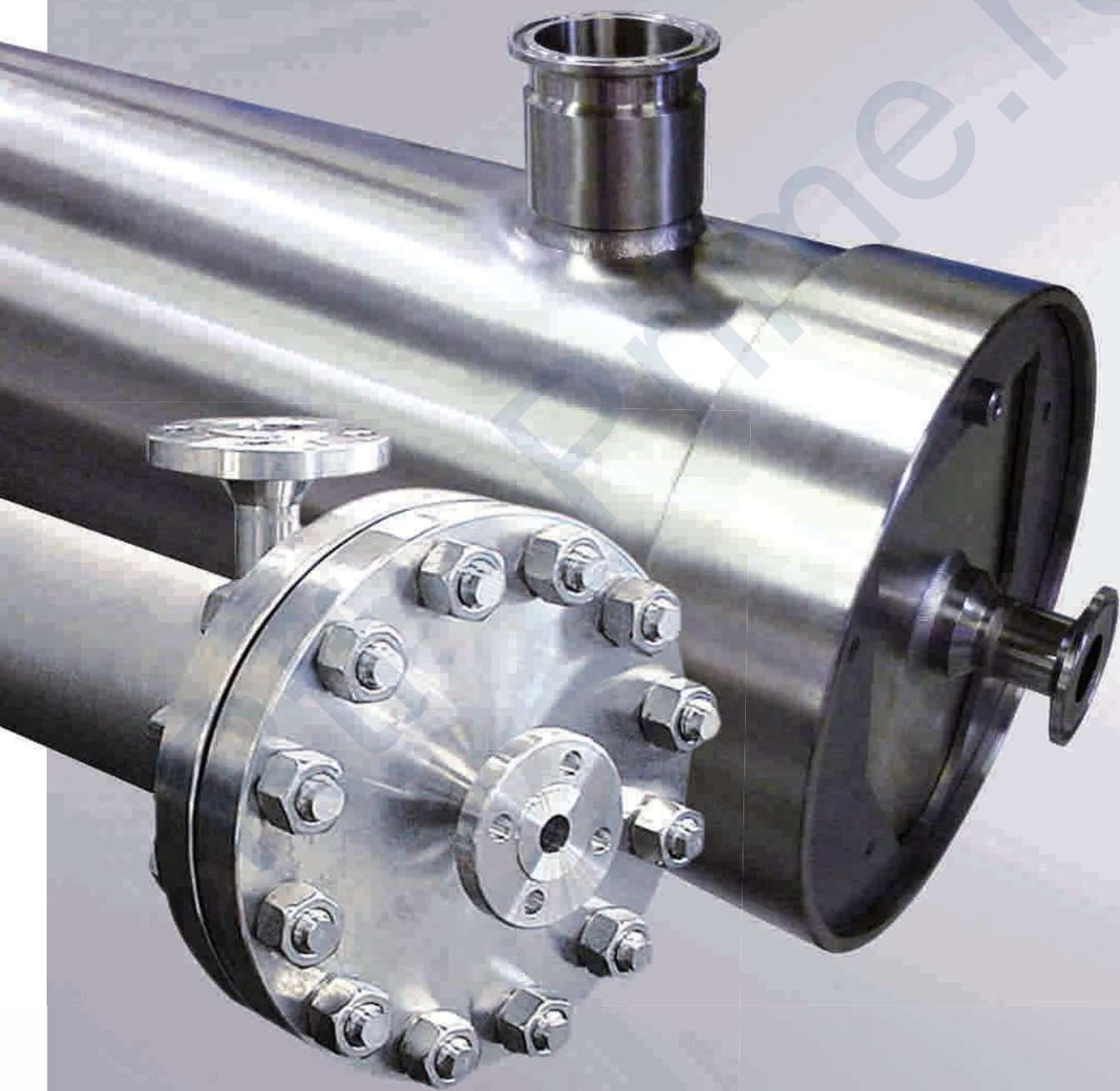

Examples of our membrane housing and plant production

Membrane housings 8"

With four module seal variants and three tube wall thicknesses, we offer the optimal solution for every pressure range in two surface qualities.



Membrane skids

Skids for membrane housings with intermediate and end modules to ensure optimal flow distribution and to save piping cost. We can also deliver skids for membrane housings as skids with manifolds.



Membrane plants

If desired, we can handle the complete plant construction.



Special housings

From test cell to 8" membrane housing for 300 bar, with EC unit verification according to Module G or EC type examination for liquids and gases.



Membrane housing specifications:

- › Front port and side port designs
- › Membrane housing for up to 6 membrane elements
- › Pressures up to 300 bar
- › Membrane sizes 1.8" - 8"
- › Materials:
e. g. AISI 316, 316 L, 304

FiltraLine® – cartridge filter housings and bag filter housings

Your product as a clean solution – we manufacture cartridge filter housings, bag filter housings, vent housings, condensate housings, inline filter housings, and low-volume filter housings, as well as special housings based on your wishes and specifications.

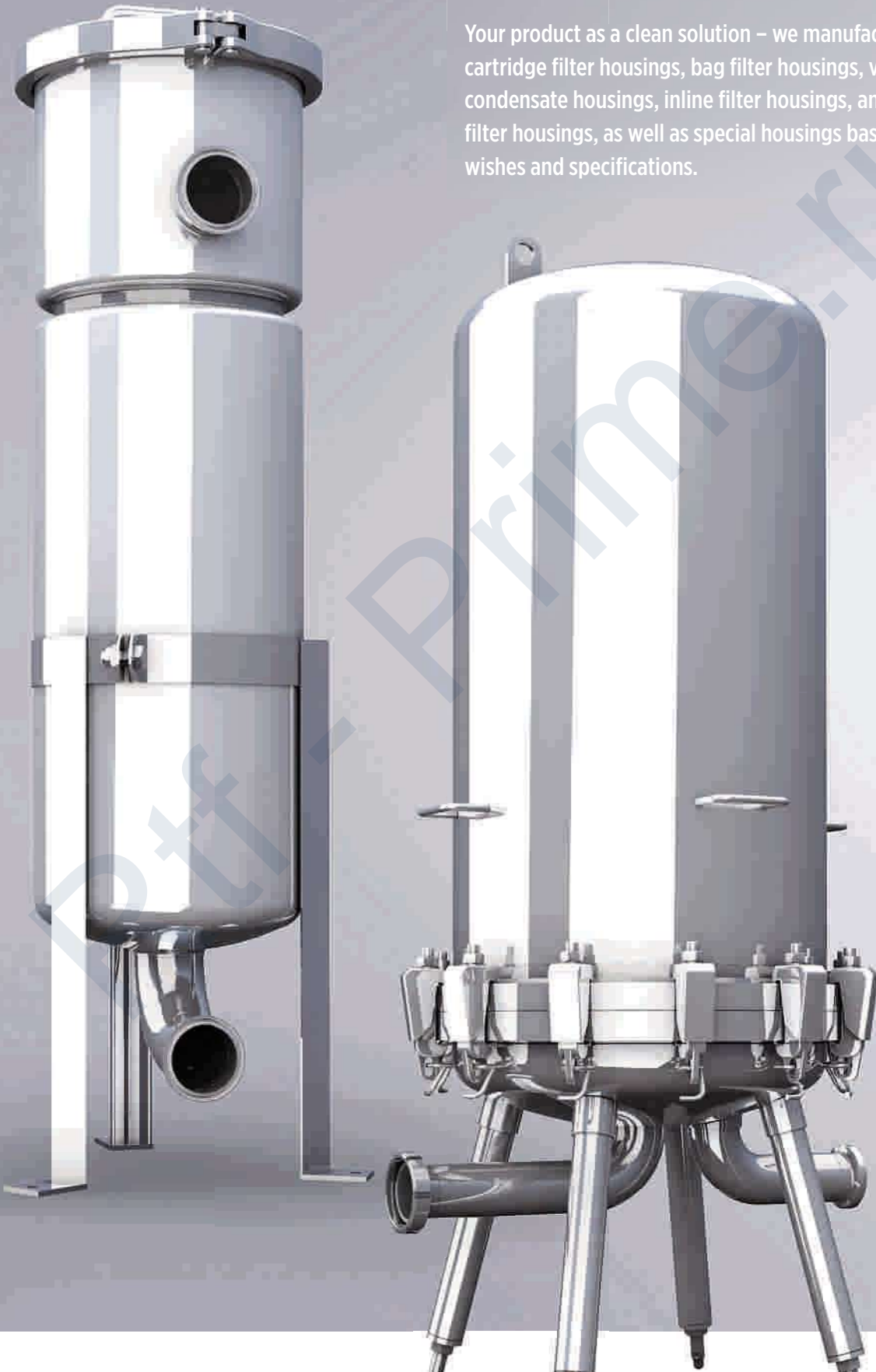

Examples of our cartridge and bag filter housing production

Parallel bag filter housing

We make standard bag filter housings for you in sizes 1 and 2.



Condensate and vent housings

In standard or individualized designs.

Filter housings with fastening bolts

To meet the highest demands, such as applications in the pharmaceutical industry.



Cartridge filter housing

Filter housing for food & beverage holds 1 to 48 cartridges.

Filter housing specifications:

- › 1x to 48x
- › Height 5" to 40"
- › Materials:
e. g. AISI 316, 316 L, 304
- › Pressures up to 160 bar
- › Custom production and special materials upon request

Heat exchangers



From your process data to the finished product – in the area of heat exchangers, we provide the support our customers need: from consulting, to calculation, to design of individualized applications, and even complete production of shell-and-tube heat exchangers.

DTS pharmaceutical heat exchangers

Additional safety for increased process reliability.



Multitube heat exchangers

Any design is possible, from industrial, to food & beverage, to pharmaceutical applications, including insulating jackets.

Heat exchanger production specifications:

- › Bundle length up to 6,000 mm
- › Ø up to 1,000 mm
- › Materials: e. g. AISI 316, 316 L, 304

Extrusions

Efficient and hygienic plant construction using our extruded distributors and connectors.

Ultra-small pharmaceutical distribution units

The smaller the better – mini is our specialty. Bore \varnothing starting at 1.5 mm, Ra 0.5 μm and the smallest diameters guarantee the highest quality for pharmaceutical applications.



Distribution units

Extruded, with welded clamp sockets, orbital-welds upon request.



Extrusion specifications:

- › Main tube max. \varnothing 356 mm
- › Extrusion max. \varnothing 273 mm
- › Length max. 6,500 mm, $t_{\text{max}} = 4$ mm
- › All standard pipe dimensions possible

Our production ... fast – flexible – first class

With our versatile and modern equipment, we can fulfill nearly any customer wish. Whether sheet metal processing, welded constructions, turned or machined parts; our experts always have an economic solution.

Numerous references from all kinds of sectors, such as the food & beverage industry, chemical, and pharmaceutical industry impressively document this claim.

In addition to stainless steel, we also process special materials such as hastelloy or duplex stainless steel. The surface finishing techniques range from immersion pickling to glass bead blasting, to vibratory grinding, hand polishing or electropolishing.



Turning, machining, grinding

Conventional, cycle-controlled and CNC-controlled turning up to $\text{\O}1,500$ mm (also with power-driven tools), CNC flatbed milling machine $3,000 \times 1,000 \times 1,000$ mm, CNC processing center with 4 and 5 axes, Flat grinding to 350×550 mm.



Automated welding

Longitudinal automated seamers and circular automatic welding machine, plasma keyhole welding, and TIG. Circular welded seams up to $\text{\O}2,500$ mm, longitudinal seams up to $4,000$ mm.

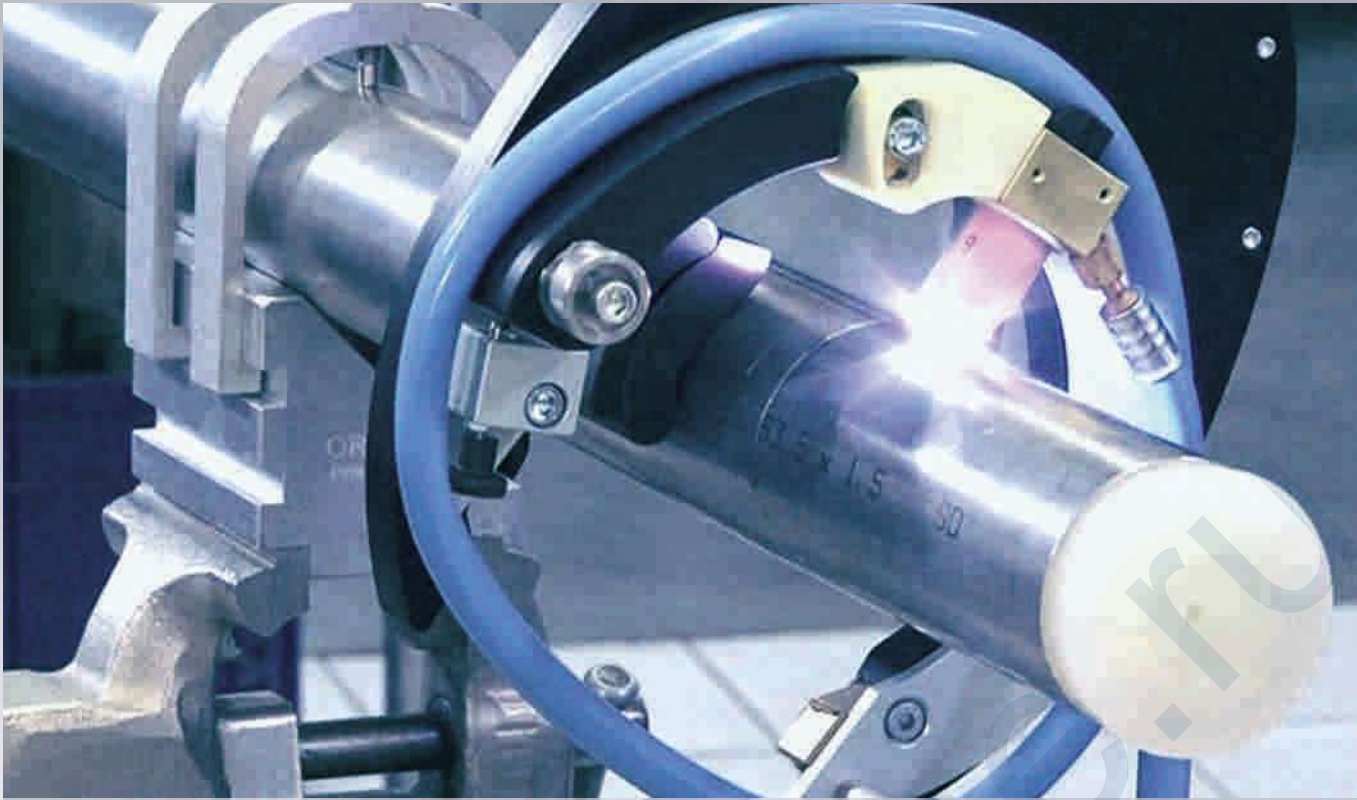

Orbital welding with open-framed or close-framed weld head.



Manual welding

TIG manual workstations with turntable, MAG workstations, spot welding machine.



Finishing

Grinding to 400 grain, manual polishing to Ra 0.4 μm , immersion pickling, glass bead blasting, electropolishing.

› Current equipment list can be found at:
www.sus-bretten.de

Design and testing – perfection from the very start

For joint developments, our CAD design unit is at your disposal. Our designers' extensive experience is held in high regard, guarantees first class results, and is therefore often used as an external service.

The foundation for their work is provided by the AD 2000 regulations, EN 13445, and the ASME code. In addition, we also implement the standards of GMP, FDA, and UVV, including acceptance procedures under PED 97/23/EG.

Throughout the entire development process, quality assurance measures are applied with the aid of state-of-the-art processes.



Design

With the programs Inventor 3D and Mechanical 2D, we offer our customers the ideal prerequisites for new designs or changes in their existing drawings.



Test methods and documentation

Various test methods are carried out by us internally and can be documented for you as desired.

- › Borescope
- › X-ray
- › Riboflavin
- › Pressure test
- › Dye penetration testing
- › Surface roughness measurement
- › Ferrite measurement
- › Helium leak test
- › ATEX assessment
- › RFA material analysis
- › Individual acceptance procedure Module G under PED 97/23/EG



Certifications

- › ISO 9001
- › Approval under AD 2000 datasheet HP 0, DIN EN ISO 3834-2, HP 100 R, TRD 201
- › Internal production control and monitoring of the acceptance procedure (Module A1) under PED 97/23/EG
- › Welder qualification under DIN EN 287, EN ISO 9606, DIN EN 1418, ASME Code Section IX
- › Certified personnel for NDT under DIN EN 473
- › Welding procedure qualification / production control test DIN EN ISO 15614-1
- › Specialist operation under § 19 of the WHG



Contact us!

When it comes to stainless steel processing,
we are the right partner for:

- › Plant construction
- › Process tanks
- › Membrane housings
- › Filter housings
- › Heat exchangers
- › Extrusions
- › Custom manufacturing

Over 100 committed employees and state-of-the-art
equipment are ready for you.



Sommer & Strassburger GmbH & Co. KG
Gewerbestraße 32 | 75015 Bretten-Gölshausen | Germany
Telephone +49 (0) 72 52 93 95-0 | Fax +49 (0) 72 52 93 95-50
info@sus-bretten.de | www.sus-bretten.de